

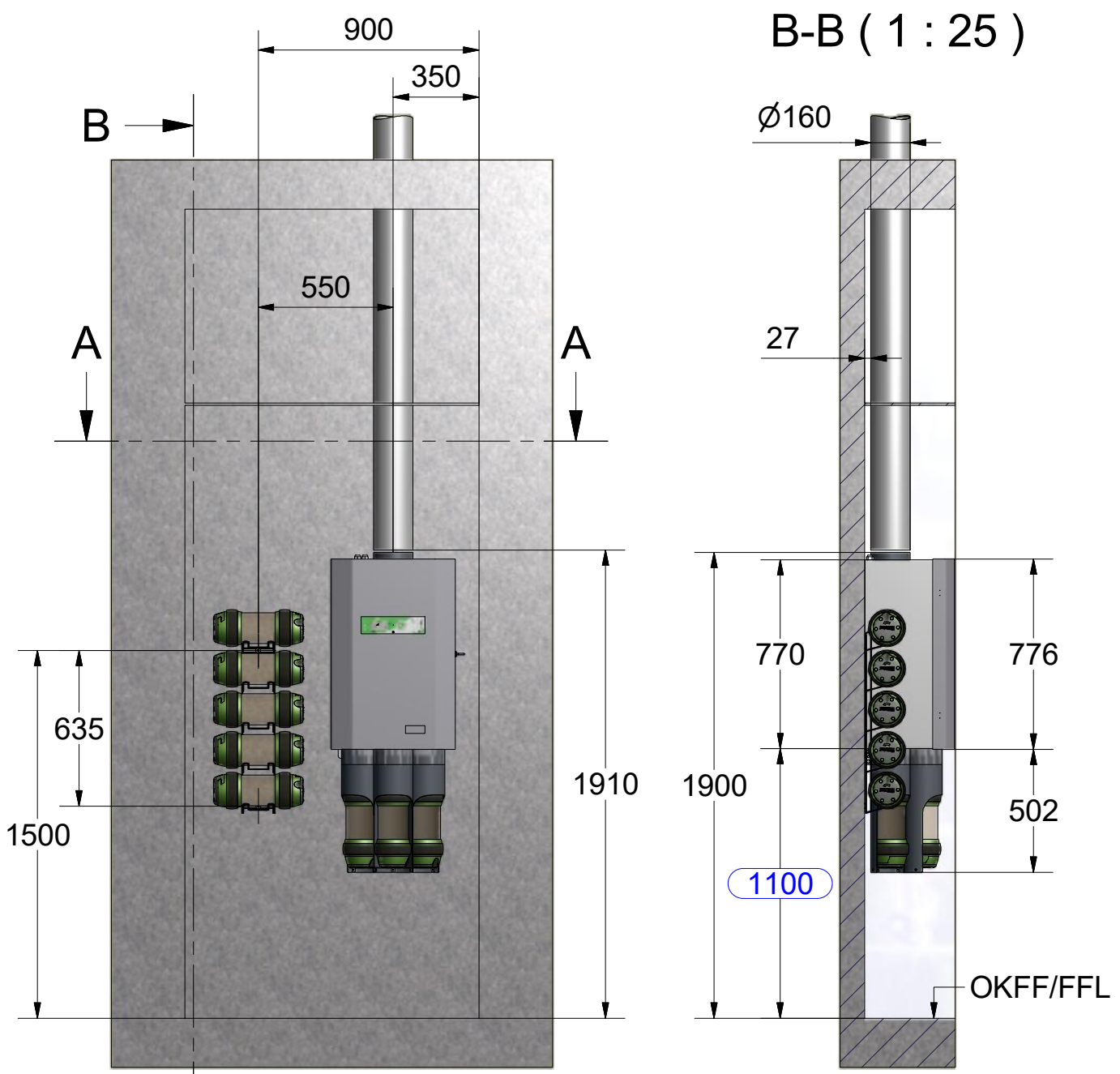

B-B (1 : 25)



A-A (1 : 25)

